

ROTATOR GR 10

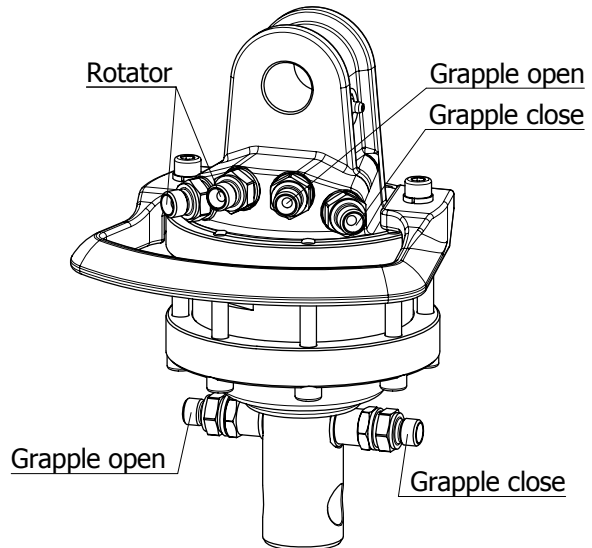
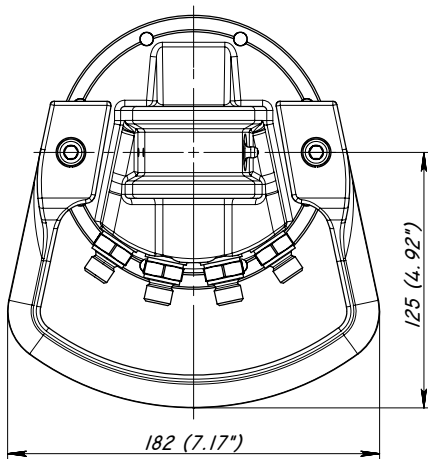
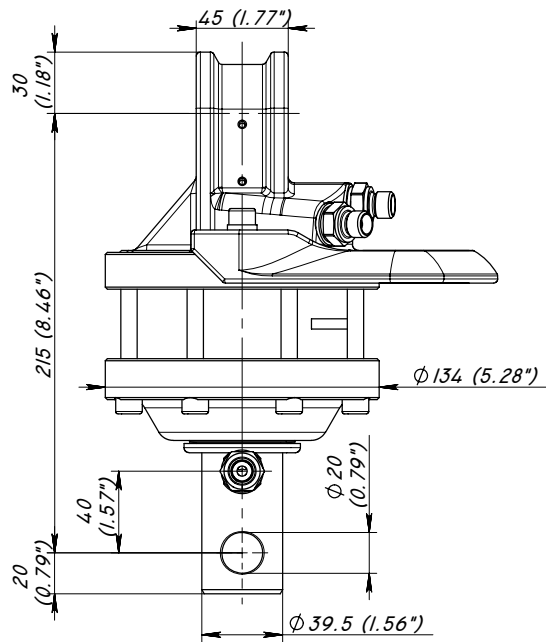
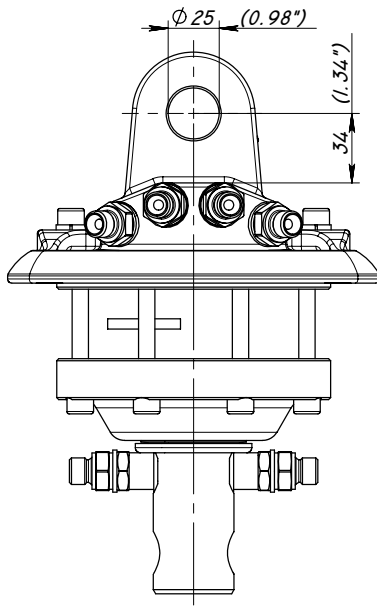

Technical data

Rotation	Unlimited
Max axial load static, KN (lbf)	10 (2250)
Max axial load dynamic, KN (lbf)	5 (1125)
Torque at 25Mpa (3625psi), Nm (lb ft)	450 (330)
Rec oilflow, l/min (US gallon)	10 (2.6)
Weight, kg (lb)	10 (22)

Max working pressure:

Rotator	←R→	Max 25 MPa (3625 psi)
Grapple / Tool open	←G→	Max 20 MPa (2900 psi)
Grapple / Tool close	→G←	Max 30 MPa (4350 psi)

Connection:

G 1/4"
G 1/4"
G 1/4"

